

# Matematyka i origami

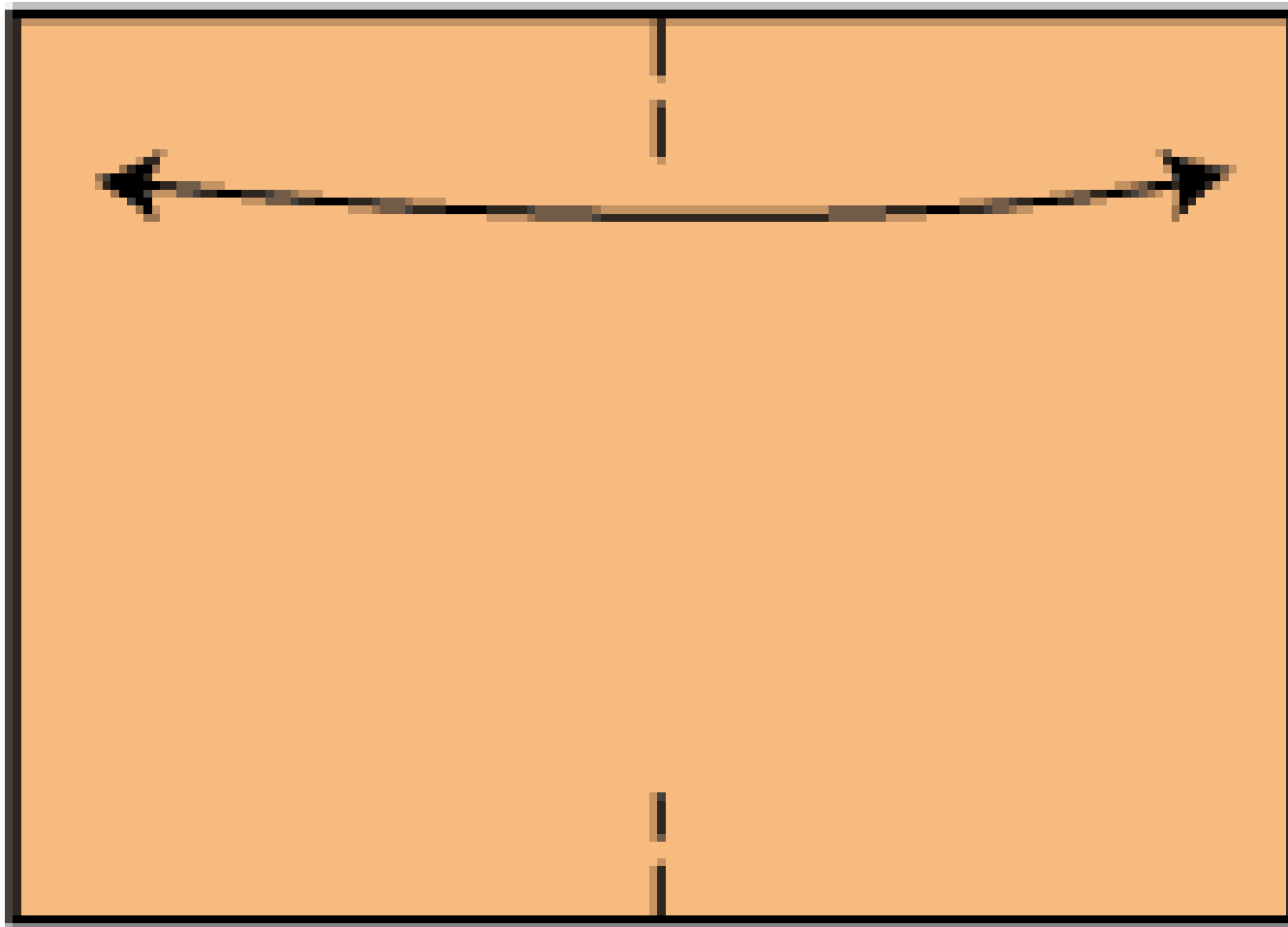

*Waterfall* (M. C. Escher)

Zadanie 0.



# Zadanie 0.

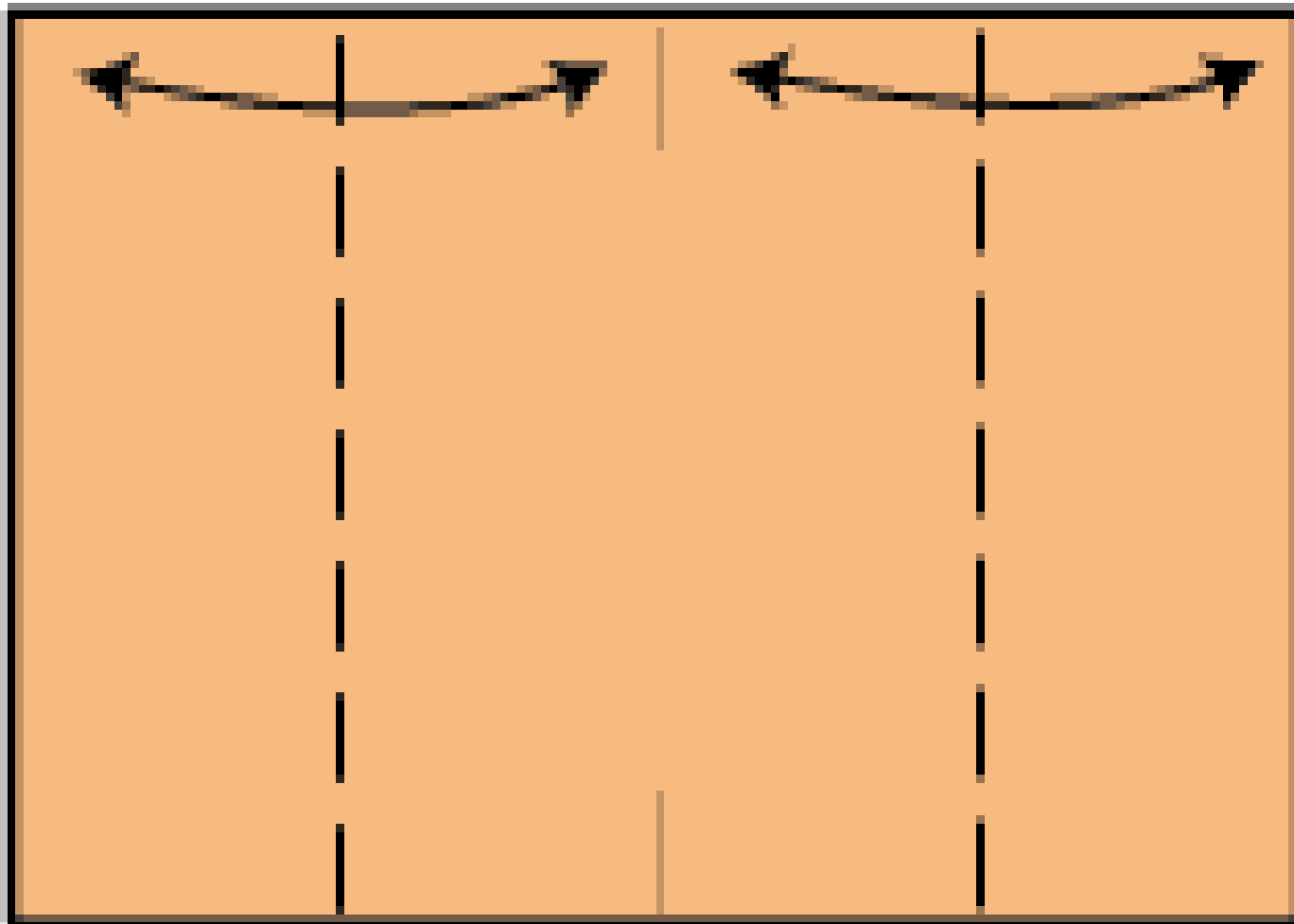

Zadanie 0.

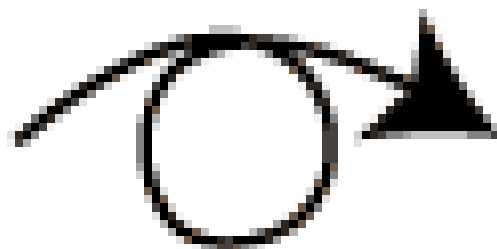

Zadanie 0.

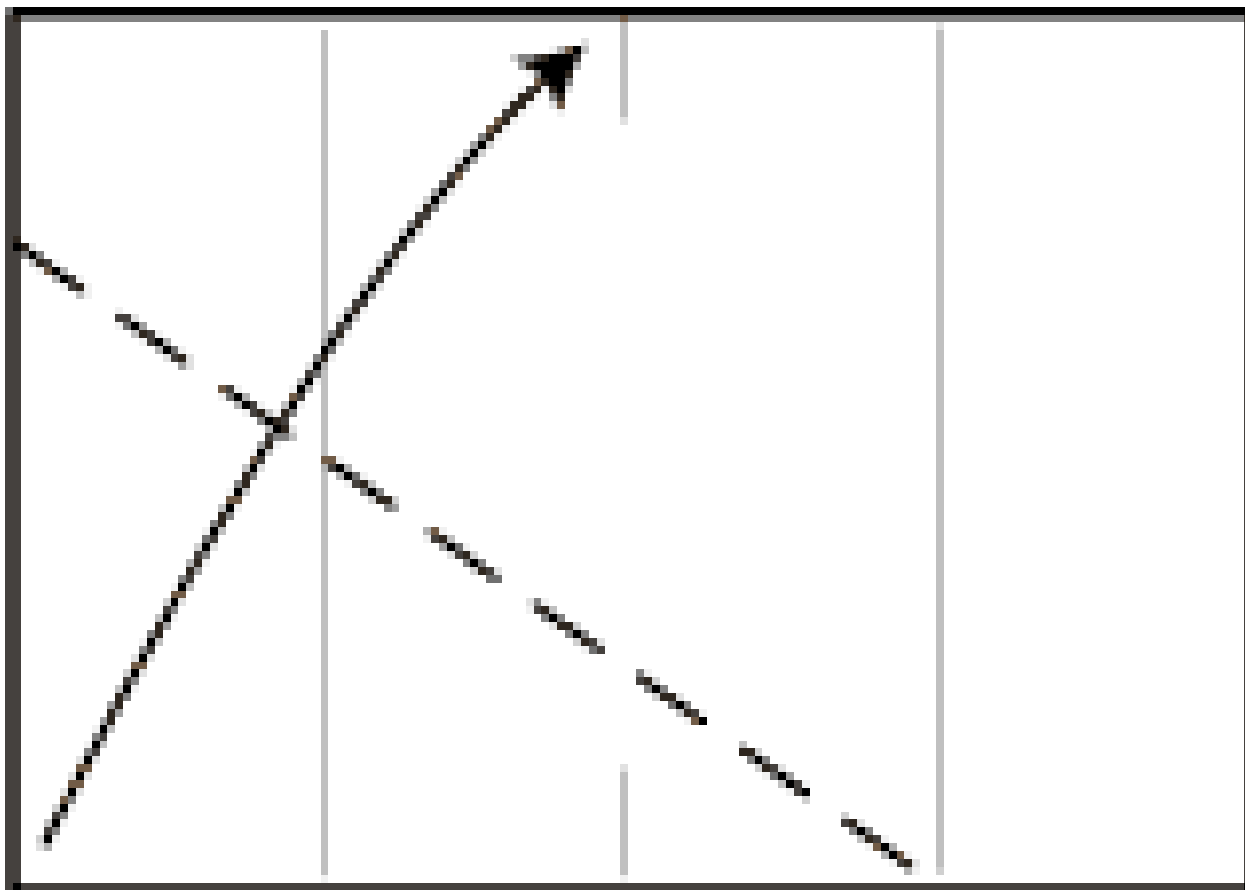

Zadanie 0.

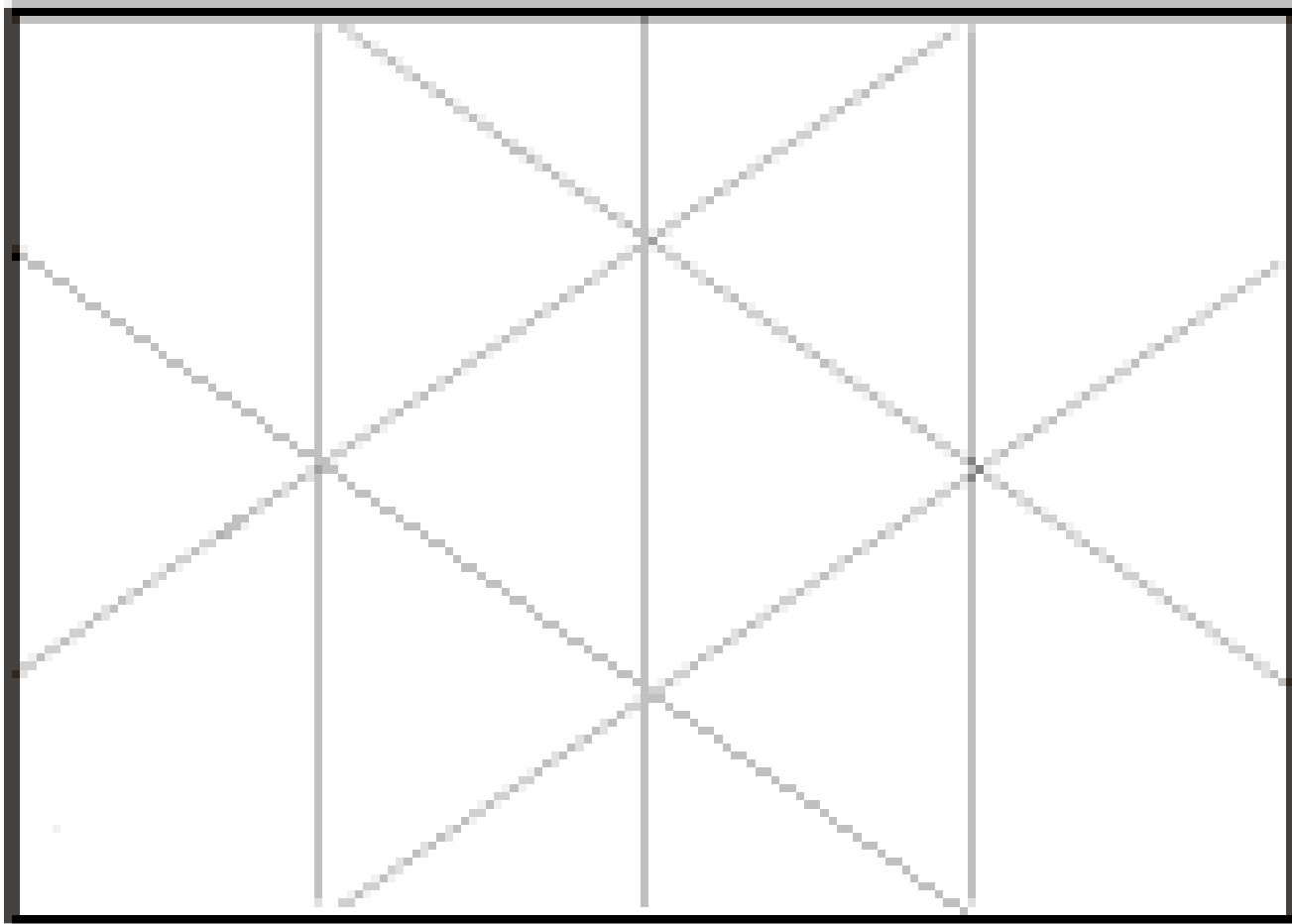

Zadanie 0.

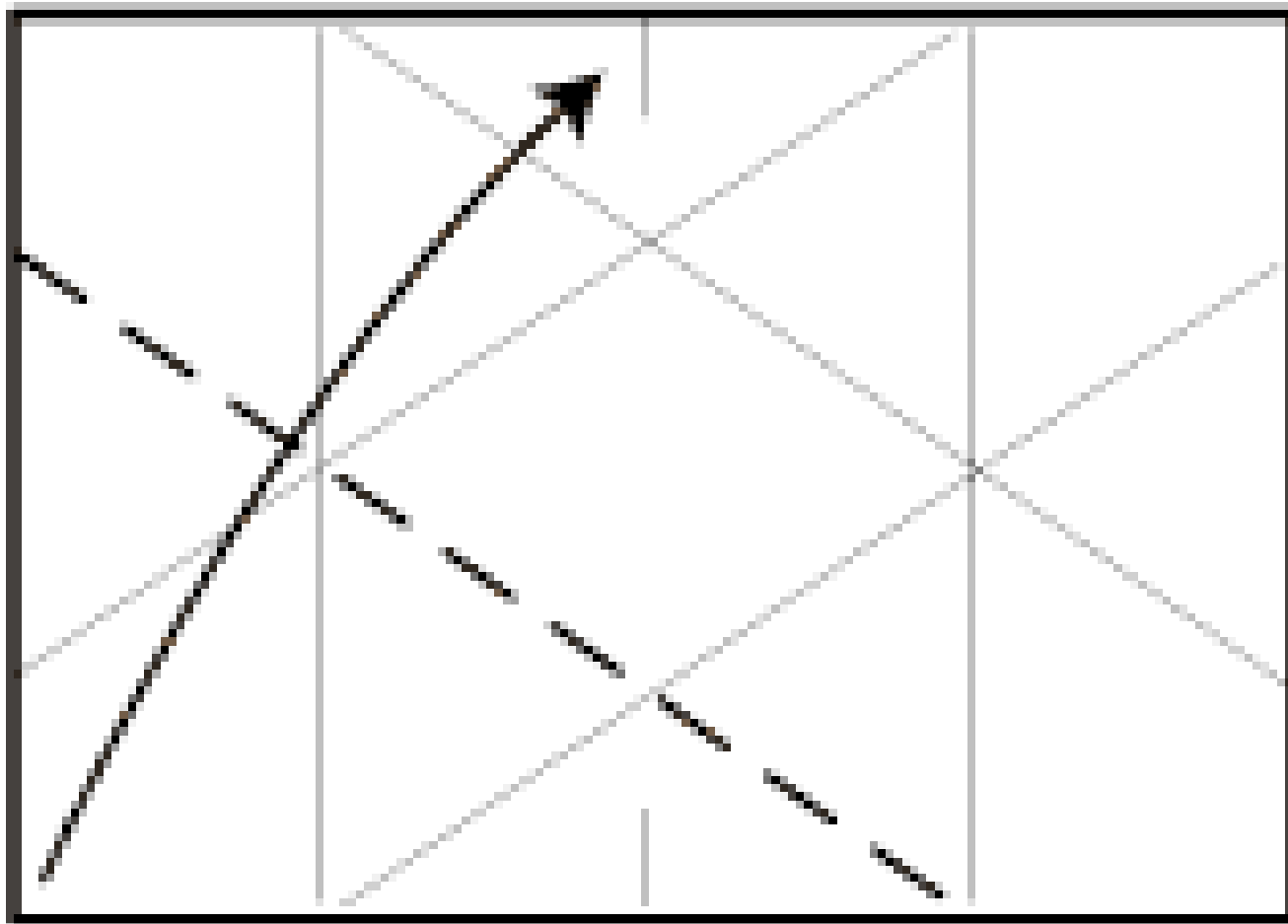

Zadanie 0.

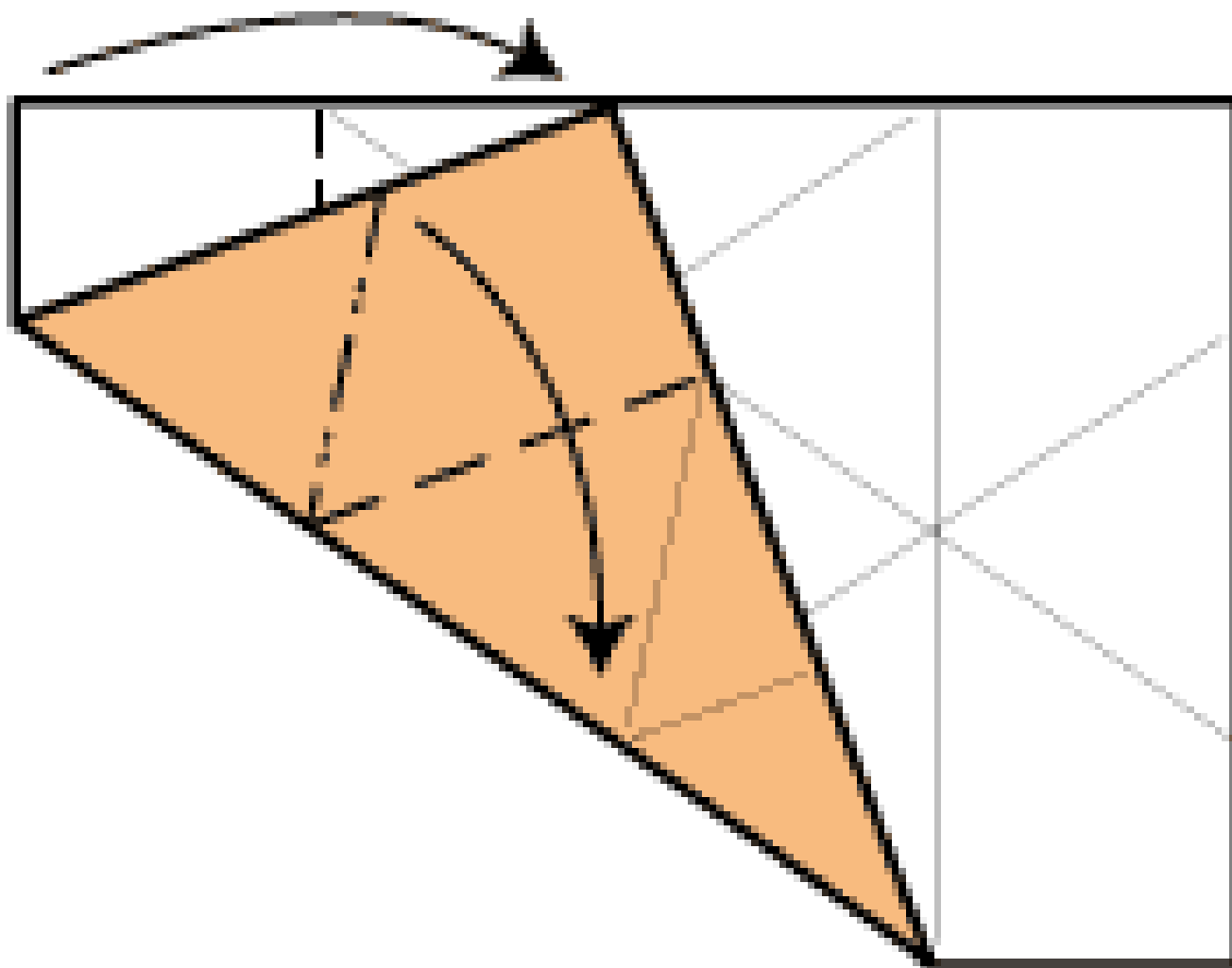



# Zadanie 0.

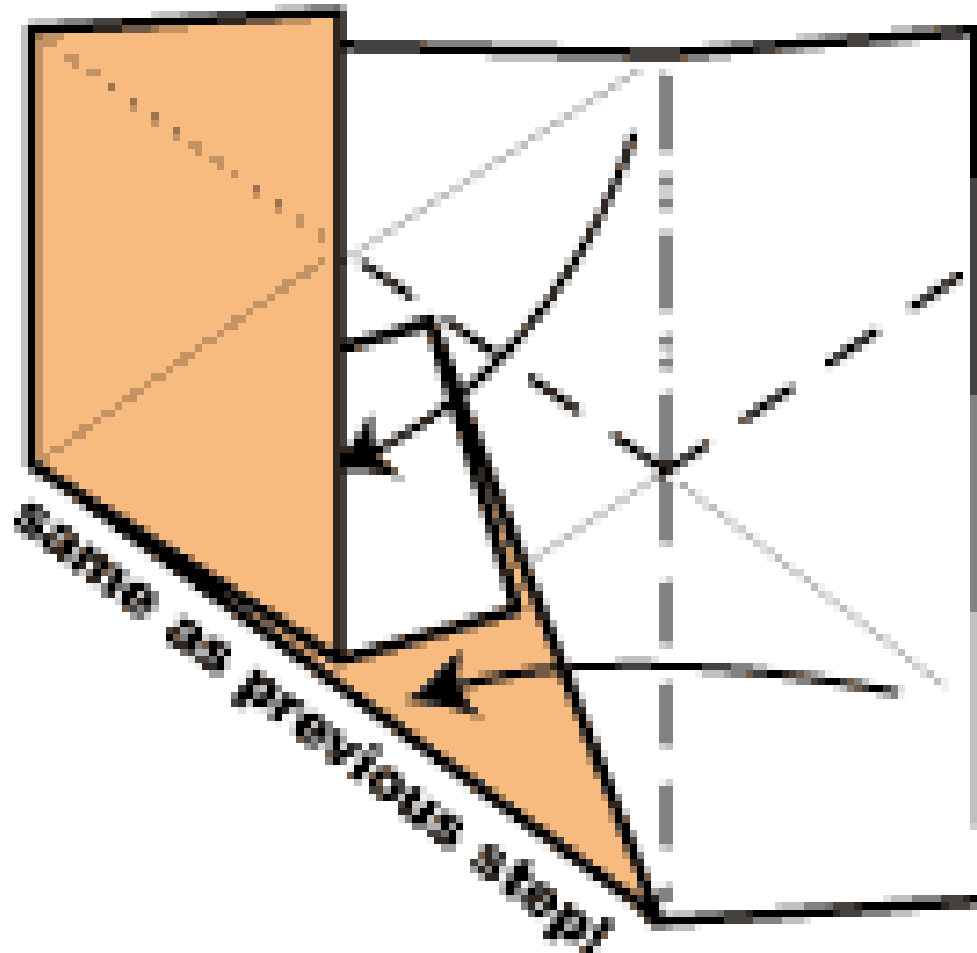

Zadanie 0.

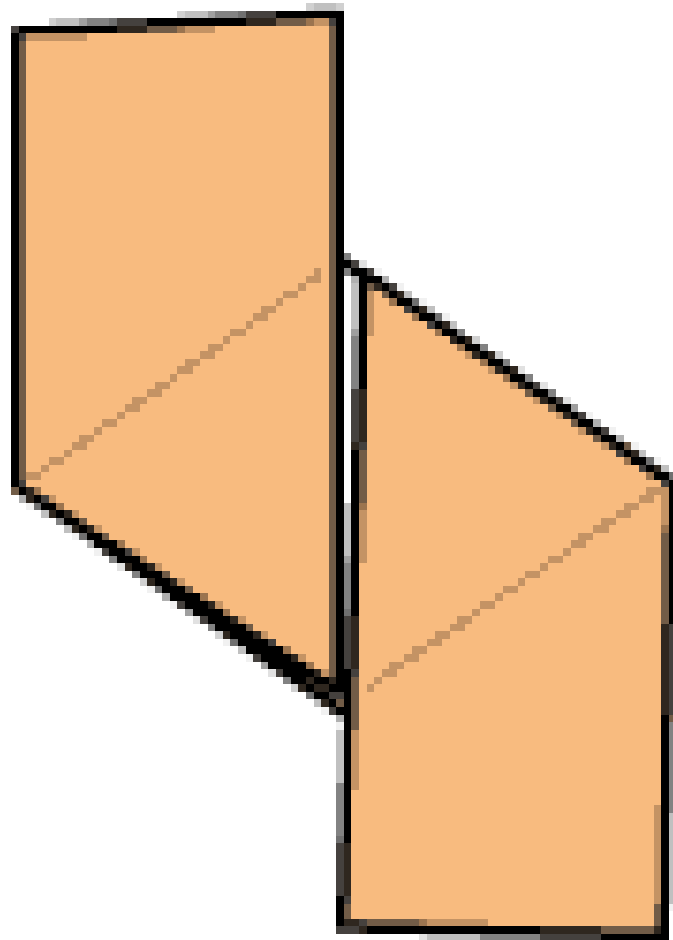

Zadanie 0.

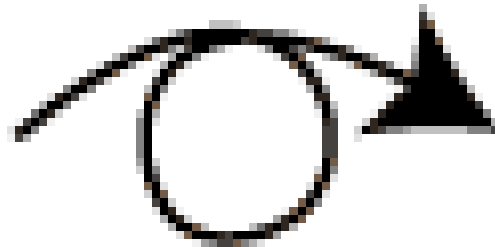

Zadanie 0.

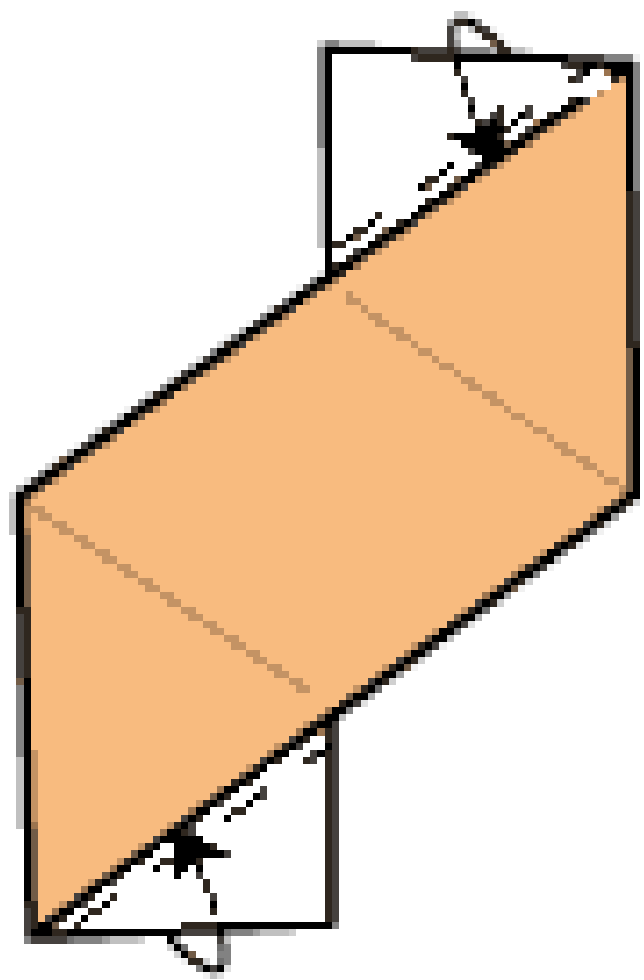

Zadanie 0.

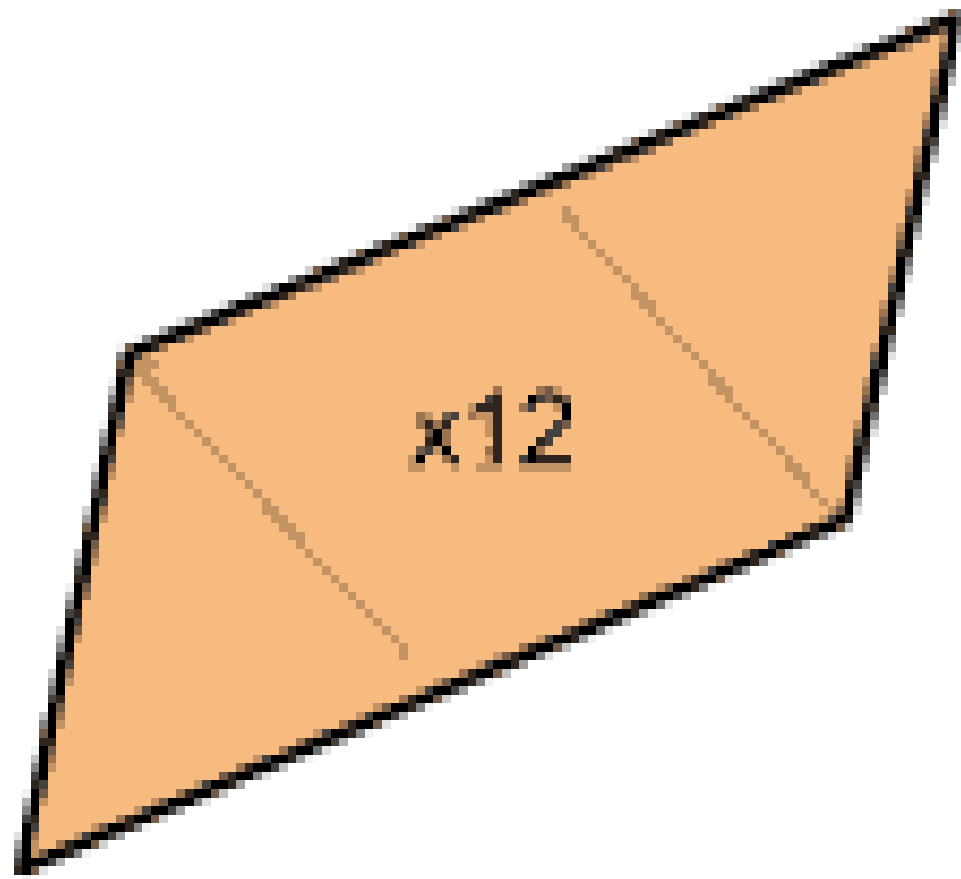

Zadanie 0.

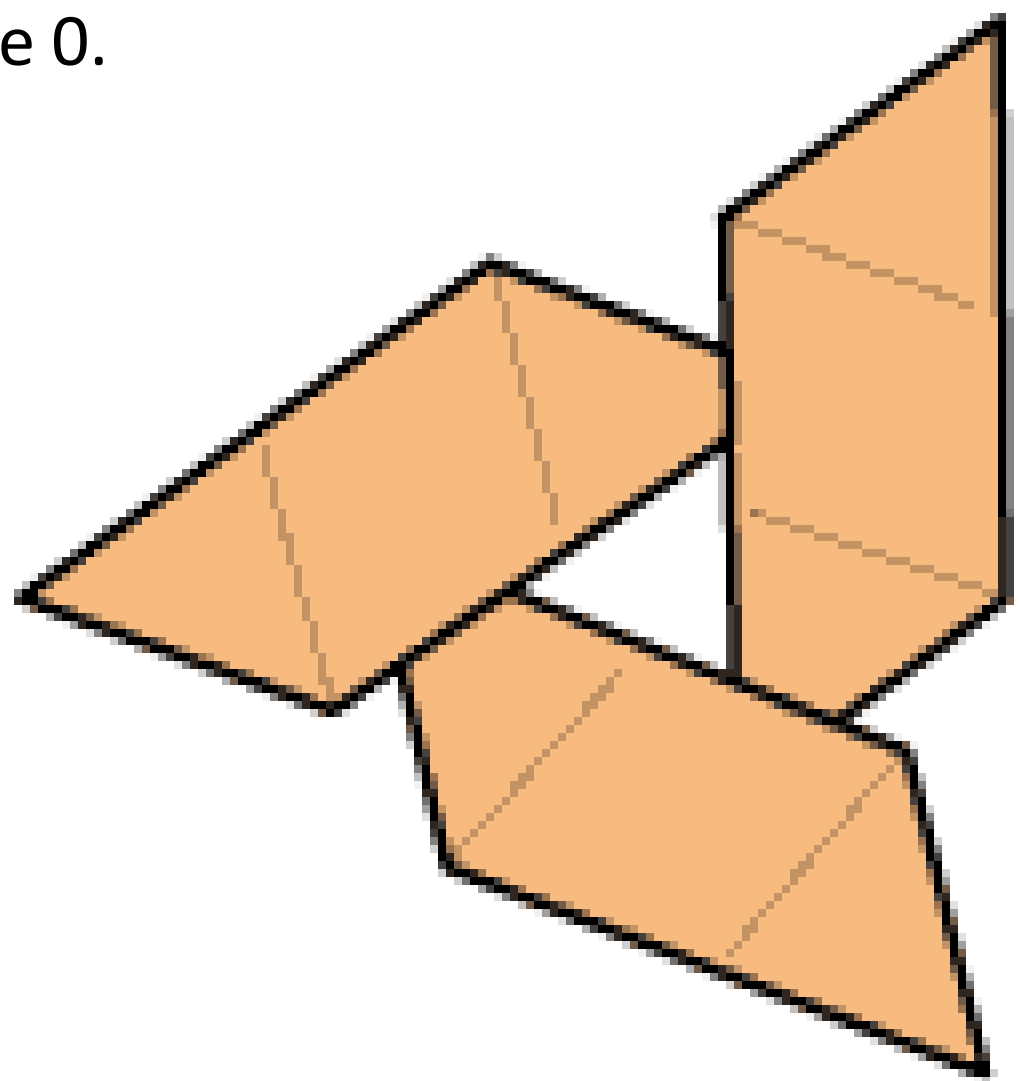

Zadanie 0.

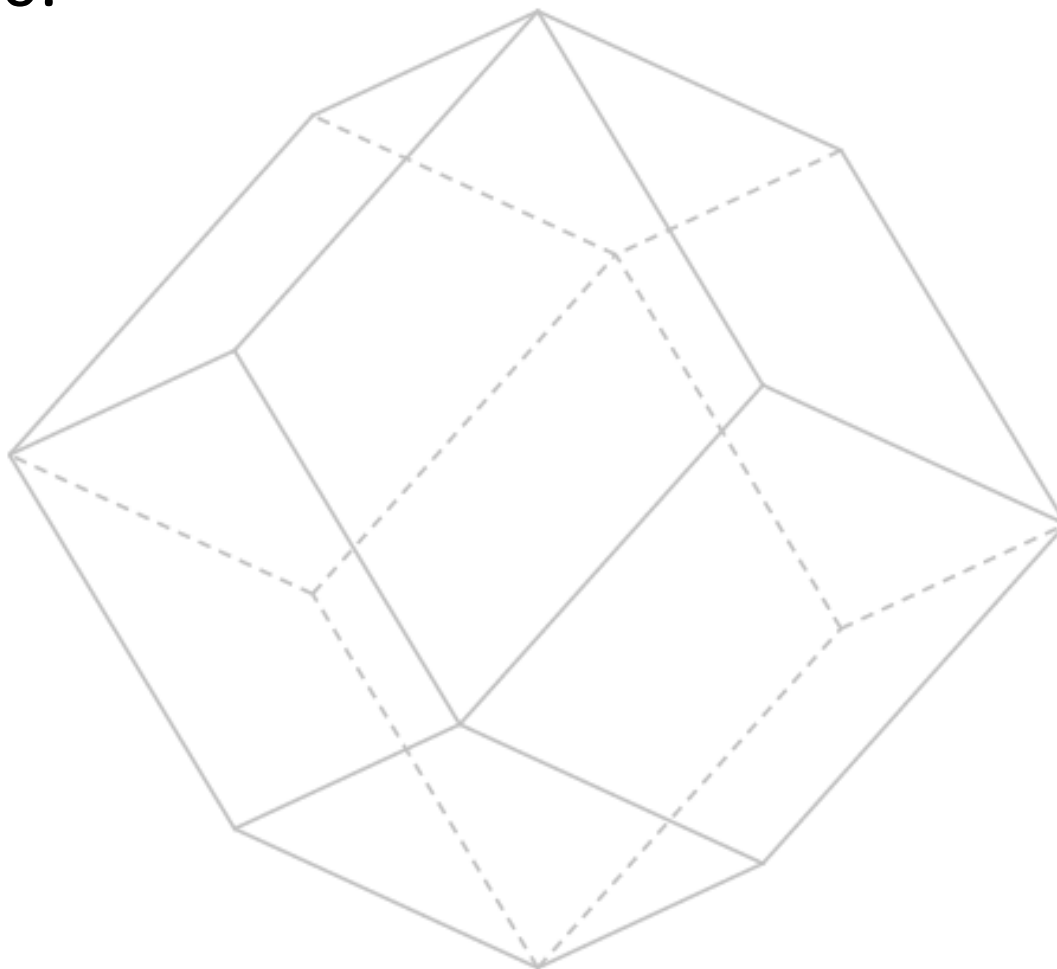

Zadanie 4.

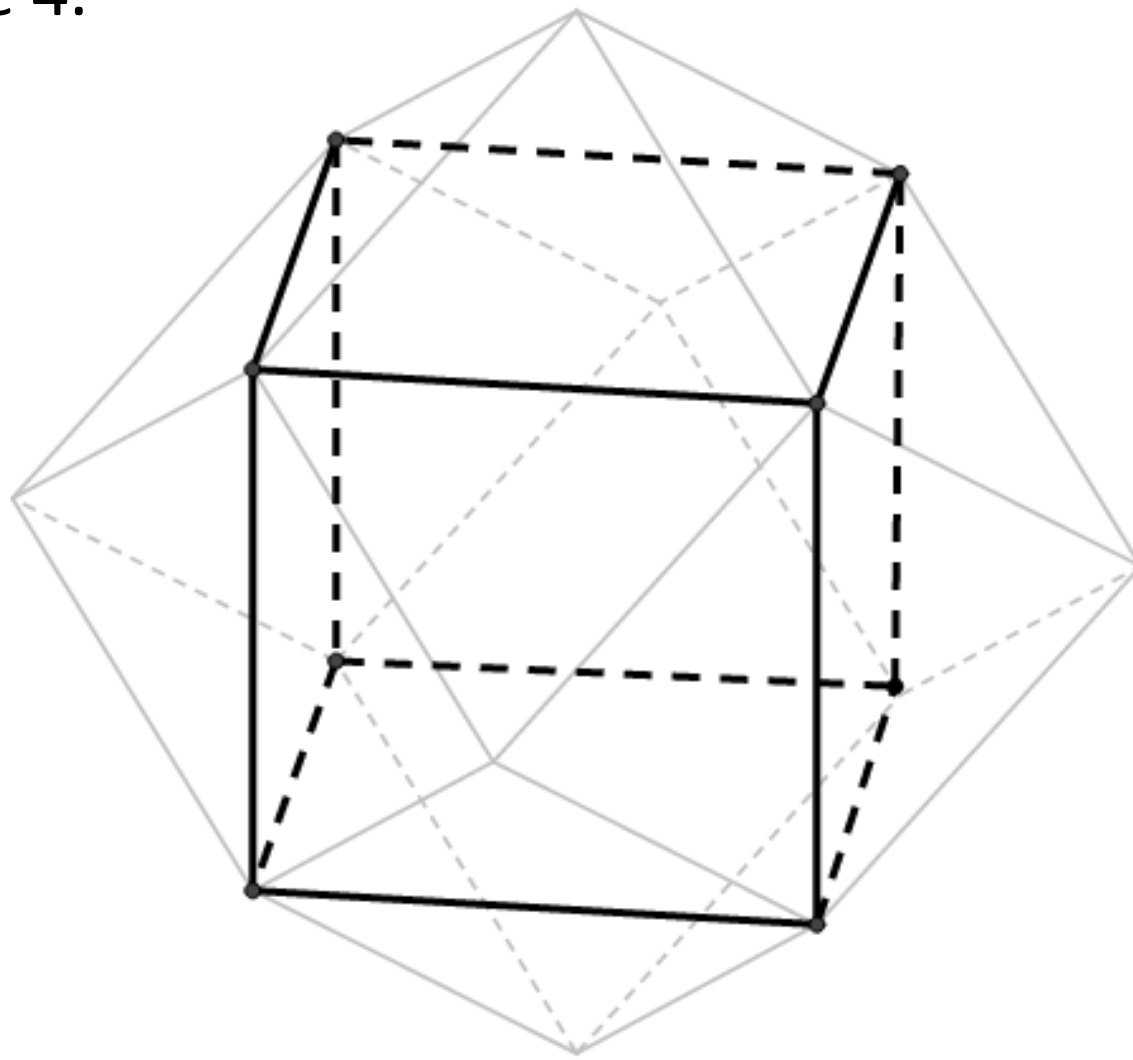



Zadanie 5.

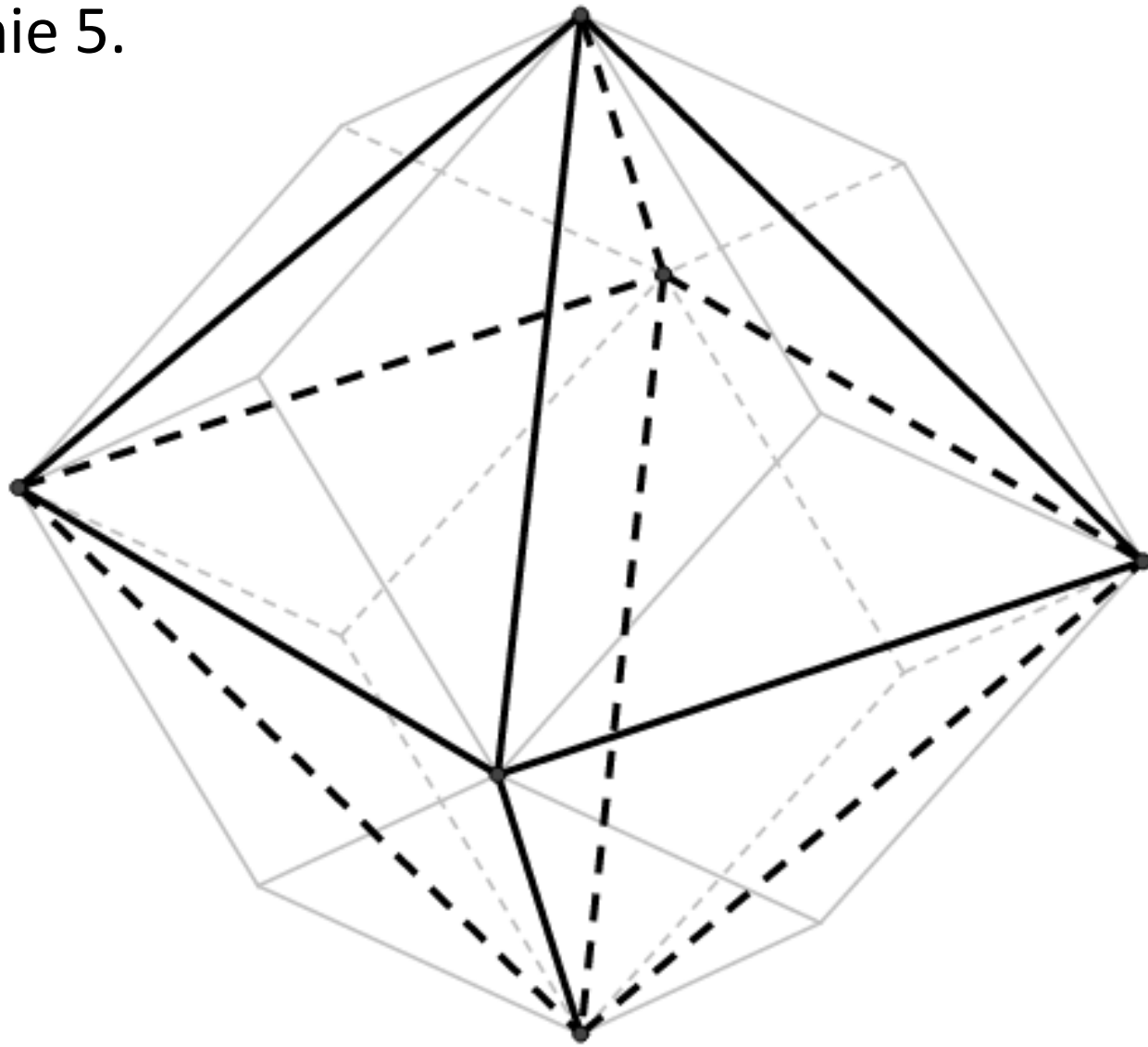

Zadanie 6.

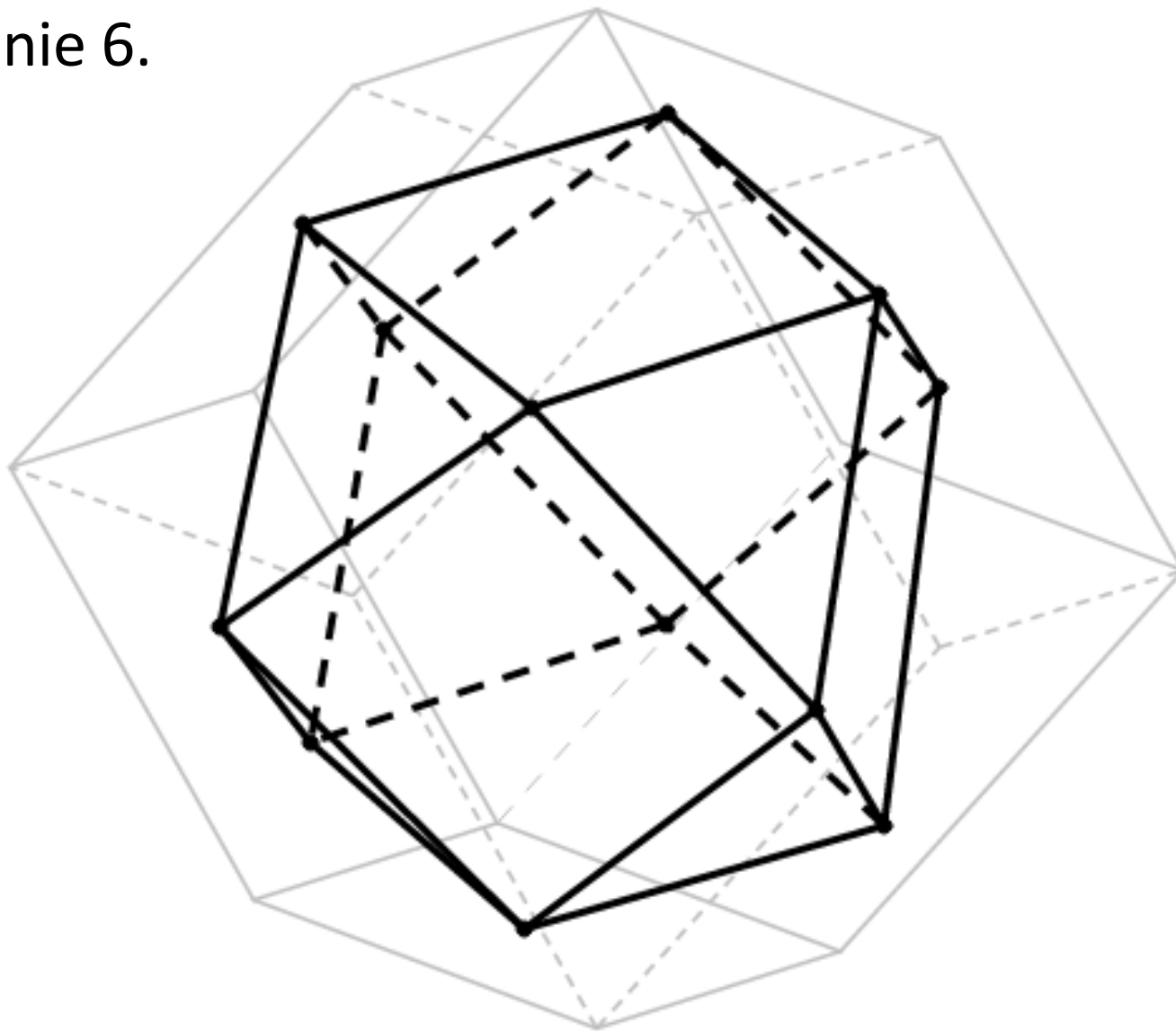

Zadanie 7.

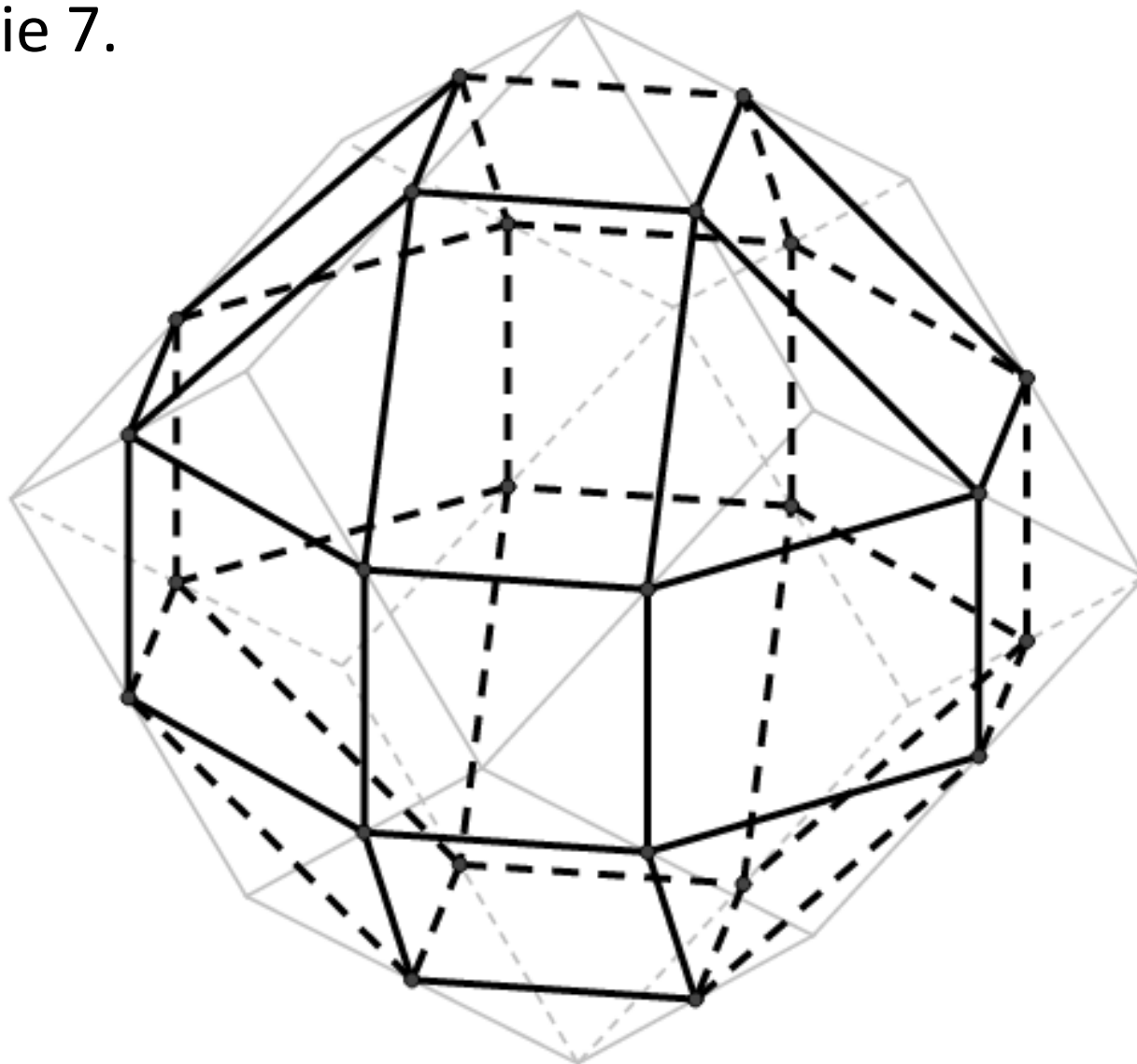

Zadanie 8.  
zabawka nr 1

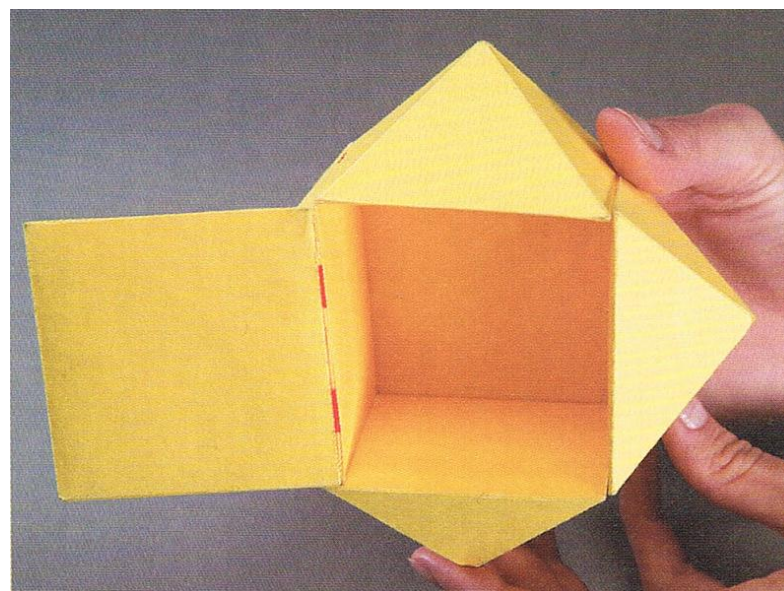
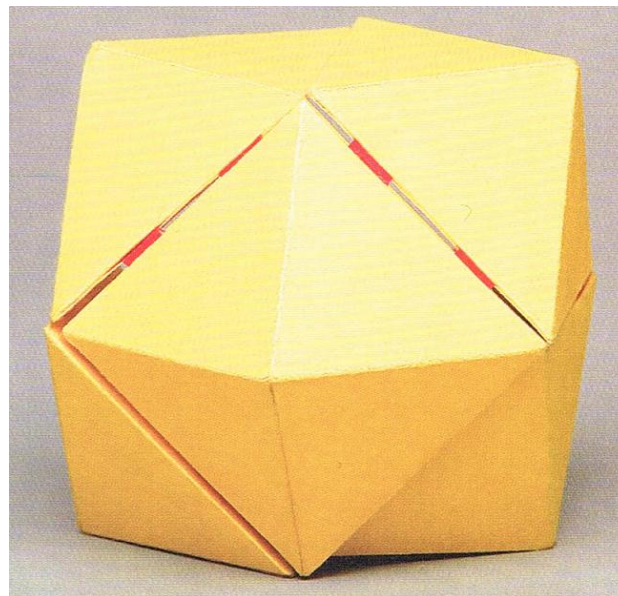



Zadanie 8.  
zabawka nr 1

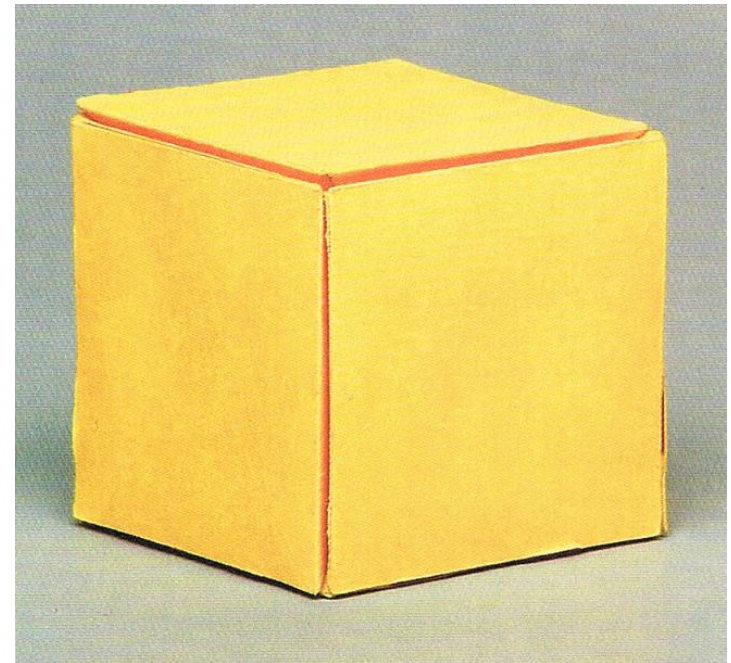
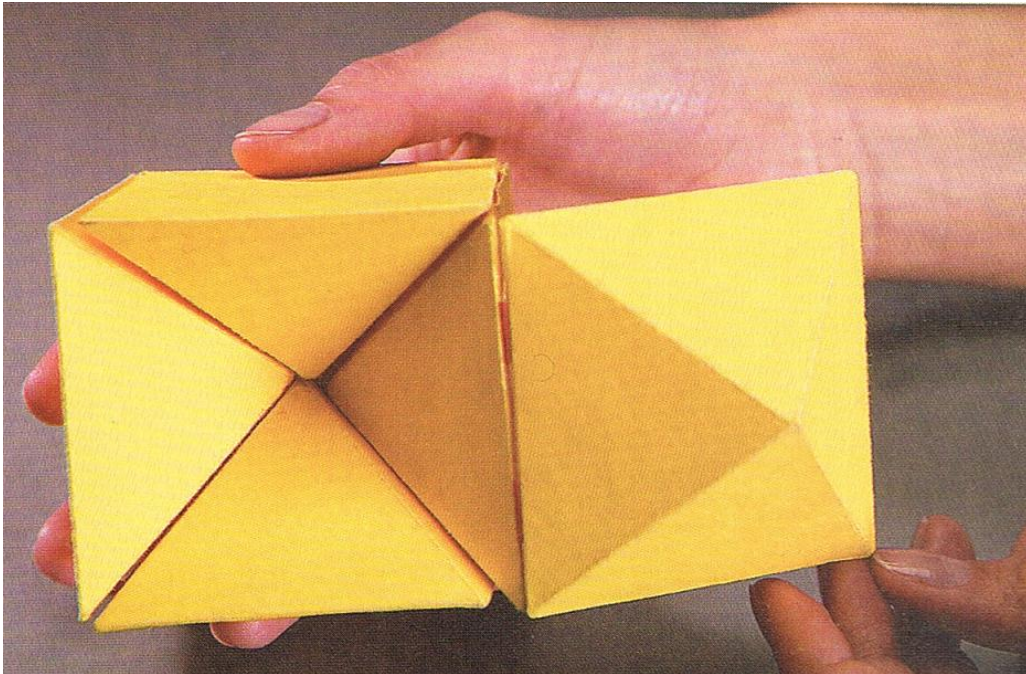
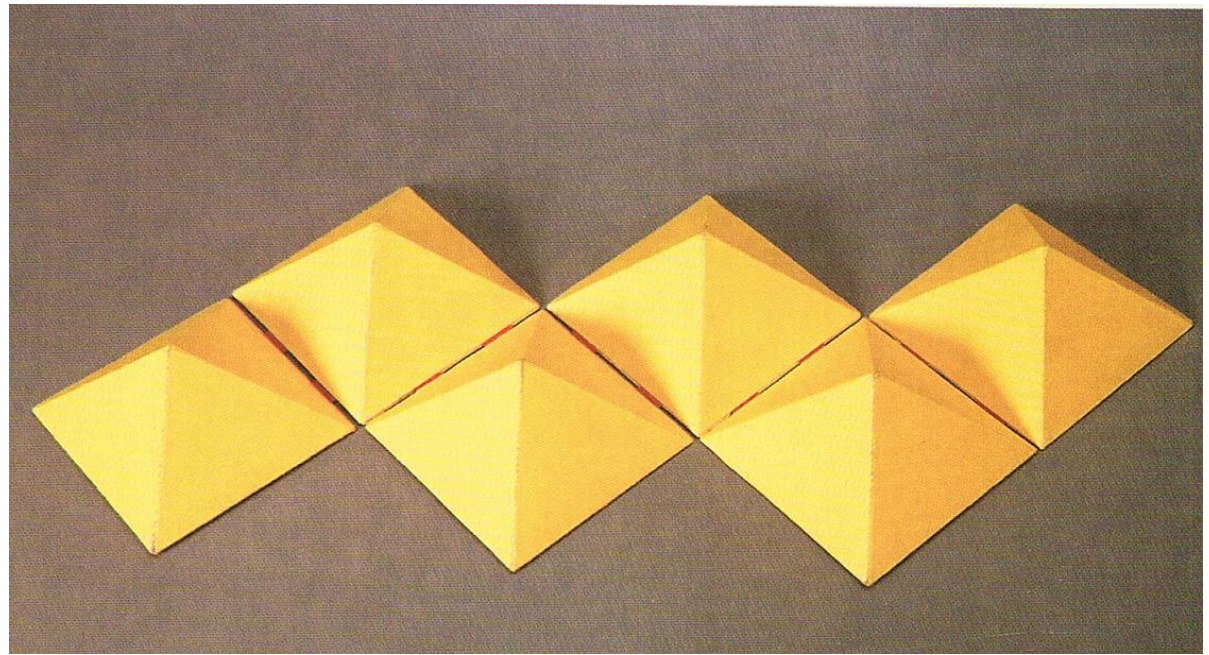

## Źródła:

- [1] <http://www.nickrobinson.info>
- [2] <http://www.matematyka.wroc.pl>
- [3] <http://geogebra.org>
- [4] P. Pawlikowski, *W krainie wielościanów. Zrób sobie bryłkę*, Wydawnictwo NOWIK, Opole 2006