

GŁOWA

baza
kwadrat

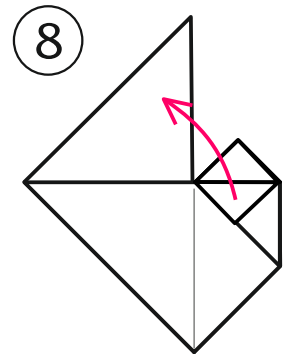

rozłożyć

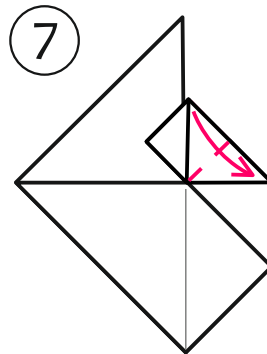
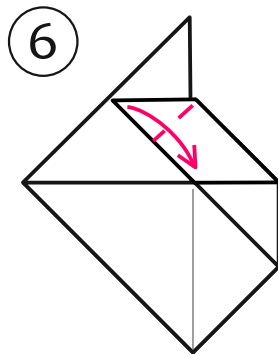
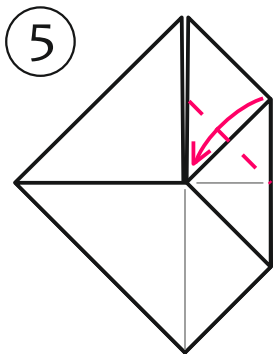
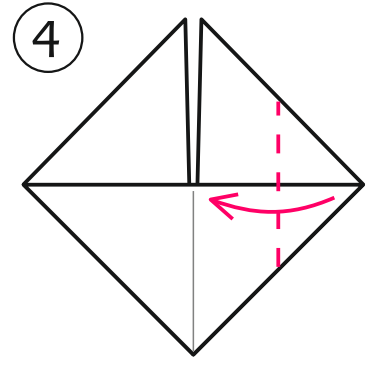
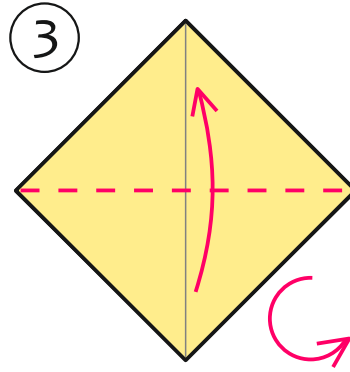
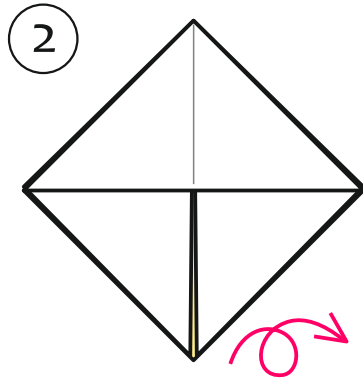
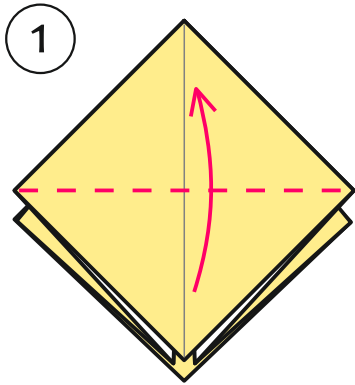
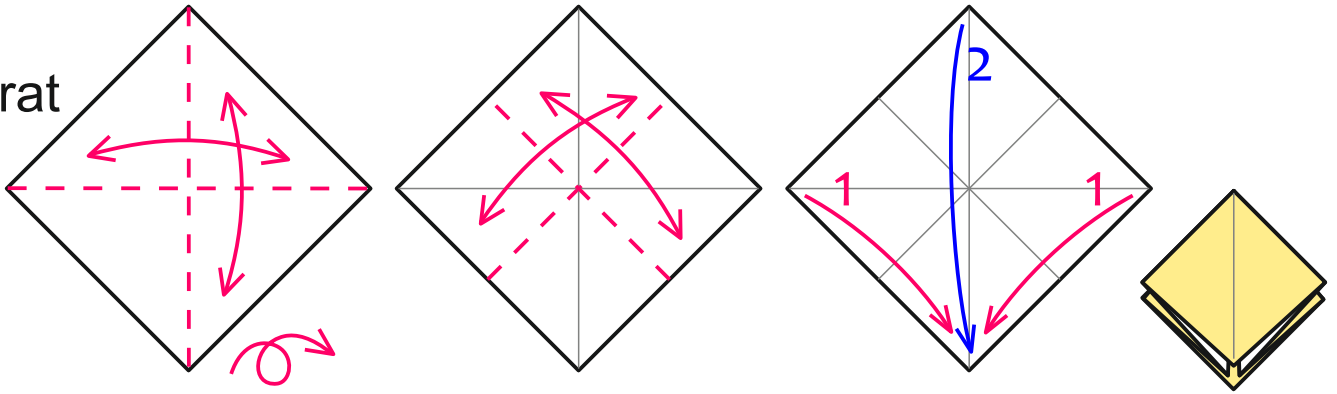
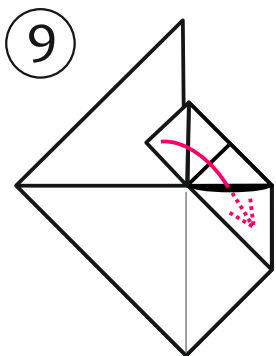

włożyć
do kieszonki

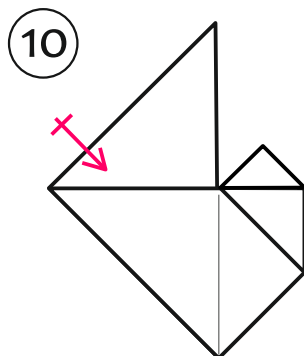

powtórzyć kroki 4-9

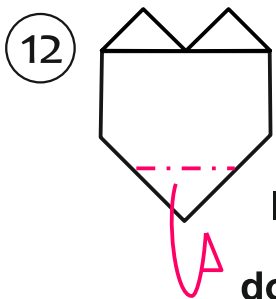
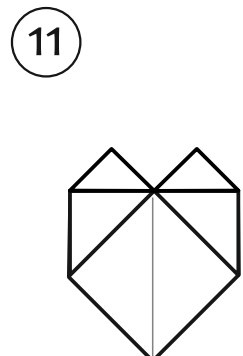

I warstwę
włożyć
do kieszonki

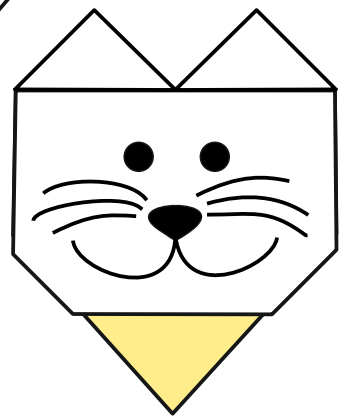
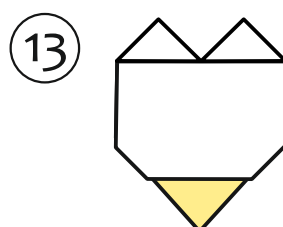

PODZIELIĆ KWADRAT NA 3 RÓWNE CZĘŚCI (DOWOLNĄ METODĄ)

1

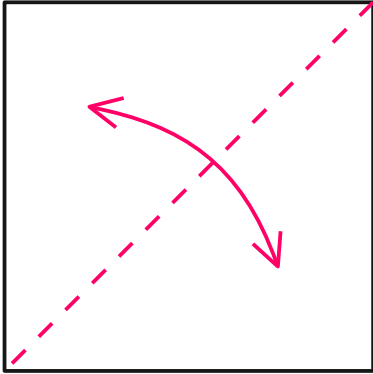

2

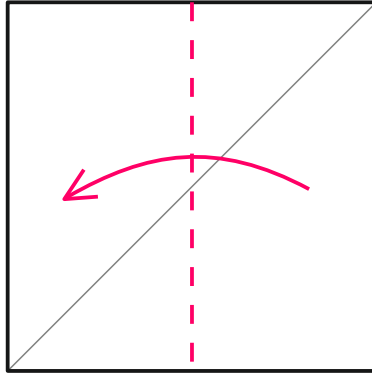

3

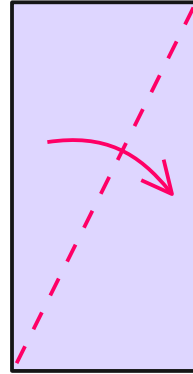

4

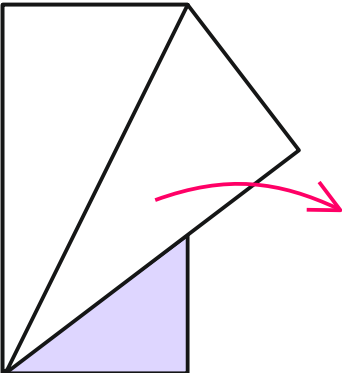

5

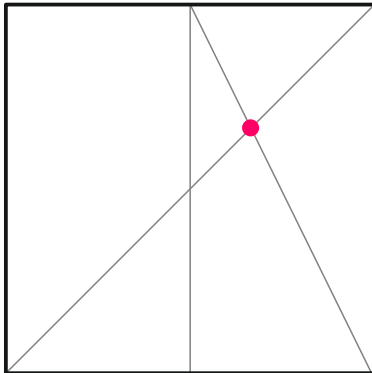

6

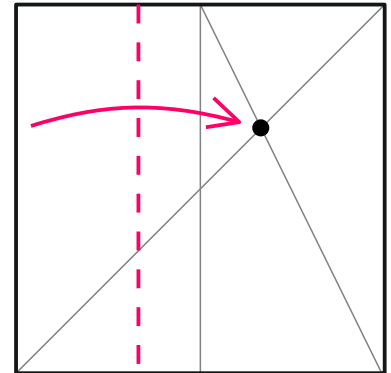

7

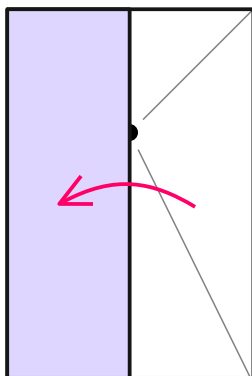

8

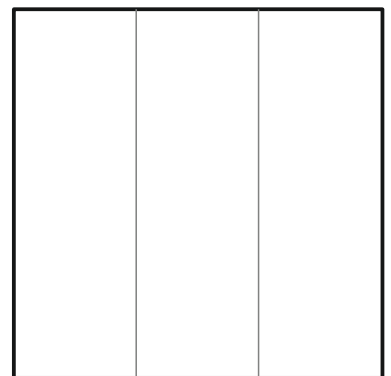
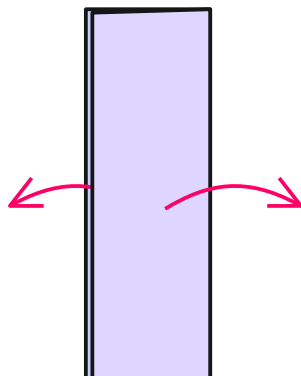

ZŁOŻYĆ 5 MODUŁÓW WG SCHEMATU

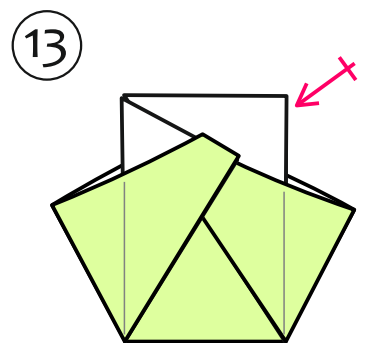
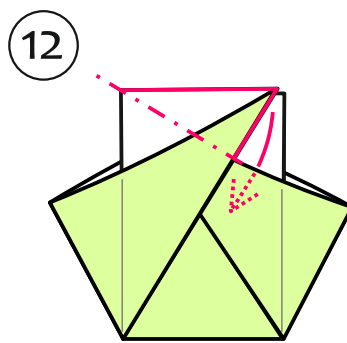
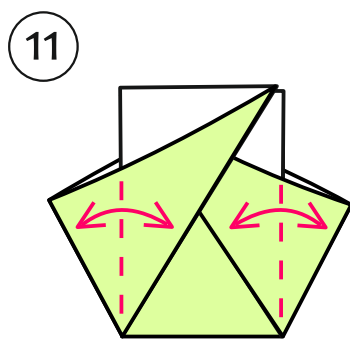
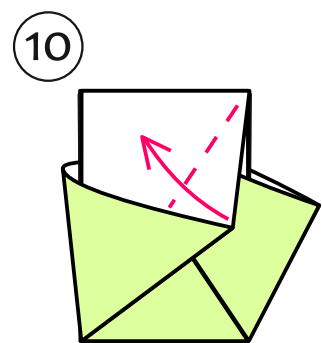
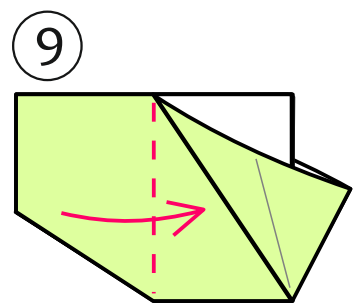
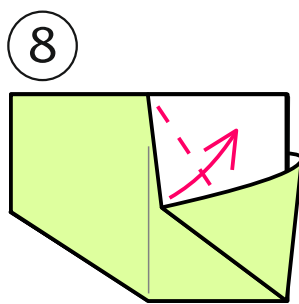
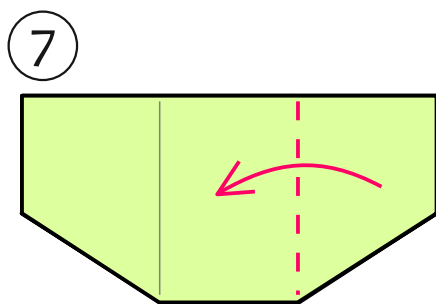
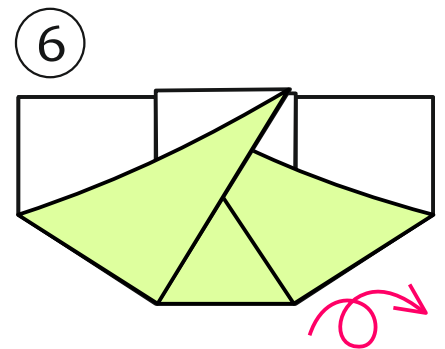
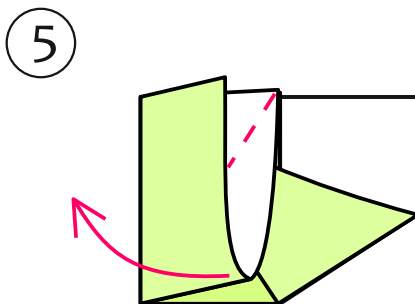
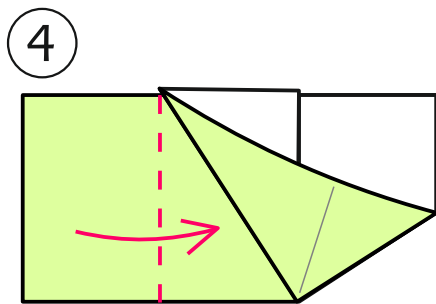
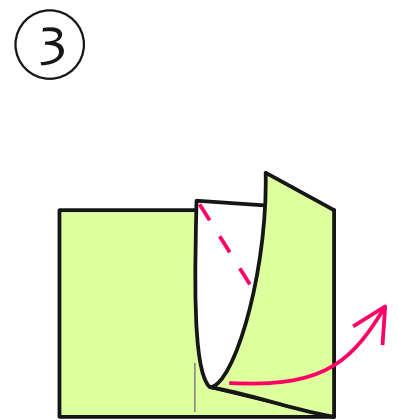
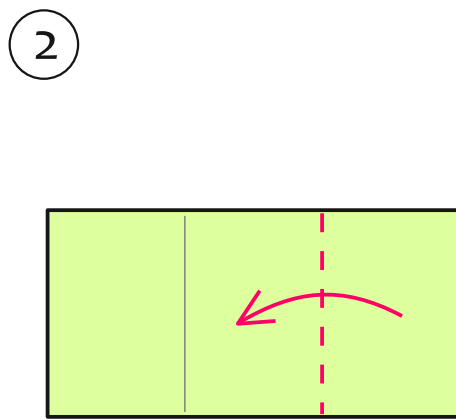
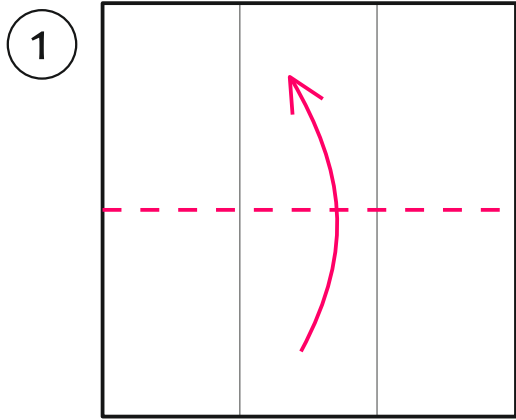

zagiąć do tyłu
i włożyć do kieszonki

powtórzyć
z drugiej strony

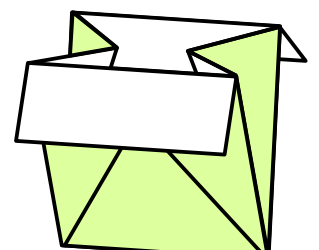
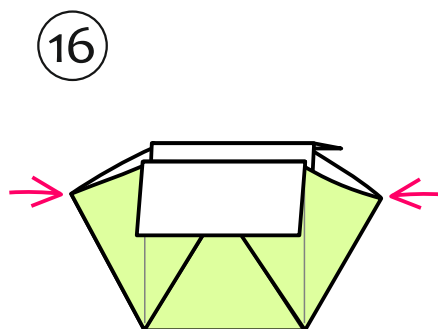
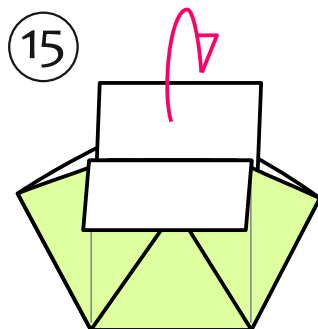
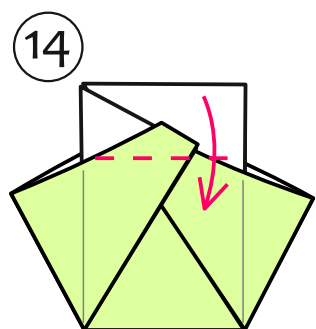

ŁĄCZENIE MODUŁÓW

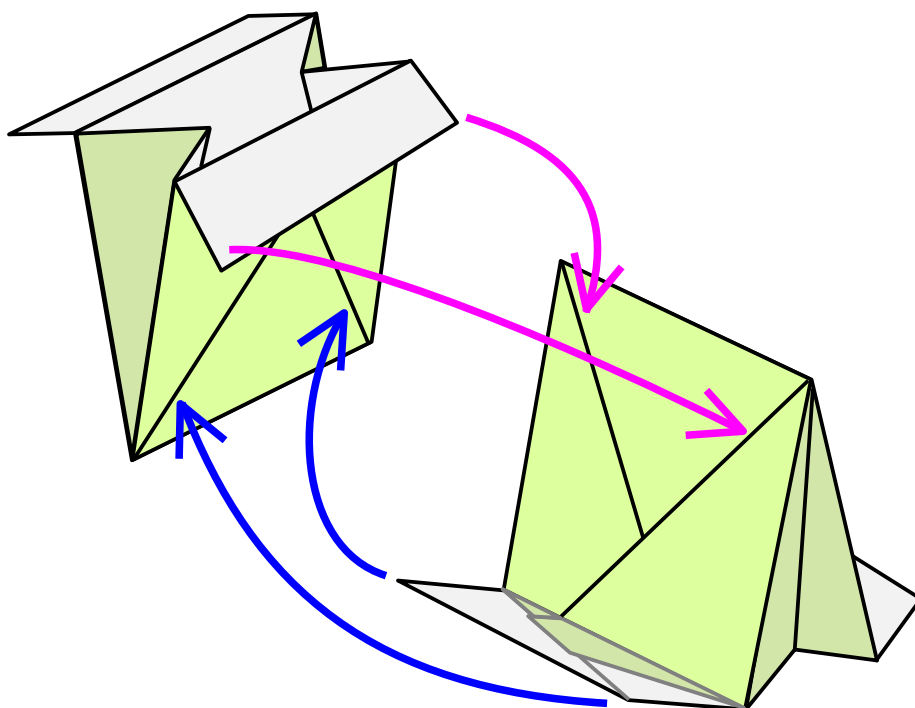

WYKOŃCZENIE

mocowanie ogona

mocowanie głowy

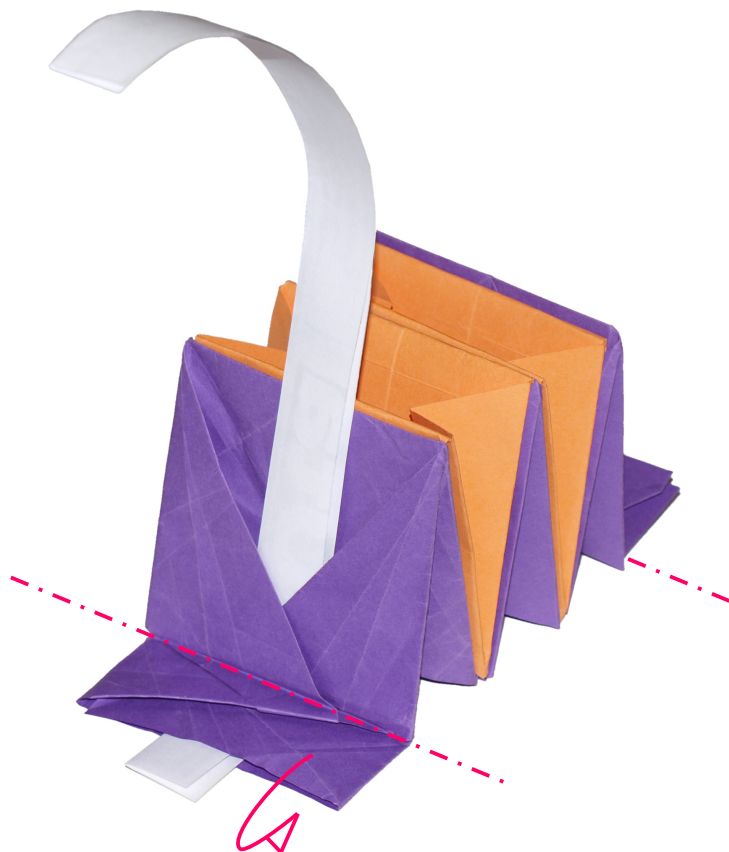

wystające skrzydełka
zagiąć do środka modułu



wystające u dołu głowy
skrzydełko wsunąć pomiędzy
dwa pierwsze moduły